



OL & OLT

Plus / Advance Series

Riser & Tank Mounted Oil Less Air Compressors

Installation, Operation and Maintenance Manual

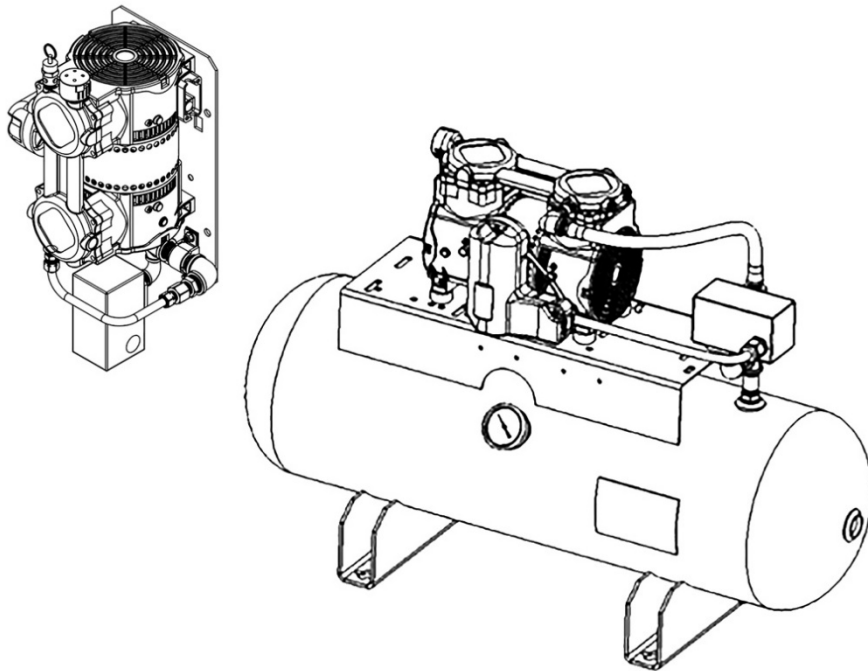

Call **1-800-345-8207**
or visit our web site for our complete product listing
www.GeneralAirProducts.com

version 2.0
04-2023

Table of Contents

Section 1 - Safety & Warnings

- 1.1 - Safety Guidelines
- 1.2 - General Information
- 1.3 - General Safety Information
- 1.4 - Safety Notes

Section 2 - Receiving

Section 3 - Installation Location

Section 4 - Mounting

- 4.1 - General Information
- 4.2 - Basic Instructions - Riser Mounting Plate

Section 5 - Lubrication

Section 6 - Piping

- 6.1 - Piping Instructions
- 6.2 - OL Riser Mounted Oilless Air Compressor Installation Drawing
- 6.3 - OL Tank Mounted Oilless Air Compressor Installation Drawing
- 6.4 - OL Base Mounted Oilless Air Compressor Installation Drawing

Section 7 - Wiring

- 7.1 - Wiring Instructions
- 7.2 - Oilless Air Compressor Single & 3 Phase Wiring Drawing with Mechanical Pressure Switch
- 7.3 - Oilless Air Compressor Single & 3 Phase Wiring Drawing with Digital Pressure Switch

Section 8 - Maintenance Instructions

Section 9 - Troubleshooting Guide

Section 10 - Warranty Policy

If there are any questions regarding installation, operation, or maintenance of this compressor, please call 800-345-8207

**IMPORTANT: ALL INFORMATION SUBJECT TO CHANGE WITHOUT NOTICE.
Consult factory for the most up to date version of this manual - 1-800-345-8207.**



WARNING

This product can expose you to chemicals including Cumene, which is known to the State of California to cause cancer and birth defects or other reproductive harm.

For more information go to www.P65Warnings.ca.gov

Section 1 - Safety & Warnings

1.1 Safety Guidelines

This manual contains information that is very important to know and understand. This information is provided for SAFETY and to PREVENT EQUIPMENT PROBLEMS. To help recognize this information, observe the following symbols.



- *Danger indicates an imminently hazardous situation which, if not avoided, WILL result in death or serious injury.*



- *Warning indicates a potentially hazardous situation which, if not avoided COULD result in death or serious injury.*



- *Caution indicates a potentially hazardous situation which, if not avoided, MAY result in minor or moderate injury.*



- *Notice indicates important information, that if not followed may cause damage to equipment.*

1.2 General Information

This compressor is intended for installation indoors for use on dry sprinkler systems in accordance with the Standard for Installation of Sprinkler Systems, NFPA 13 and the National Electrical Code, NFPA 70. The compressor should be sized to restore and maintain the air pressure in the sprinkler system in accordance with the requirements in NFPA 13.

1.3 General Safety Information

1. Read all manuals included with this product carefully. Be thoroughly familiar with the controls and the proper use of the equipment.
2. Follow all local electrical and safety codes as well as National Electrical Codes (NEC), Occupational Safety and Health Act (OSHA), and National Fire Protection Association (NFPA).
3. Only persons familiar with these rules of safe operation should be allowed to use the equipment.
4. Keep visitors away and NEVER allow children in the work area.
5. Wear safety glasses and use hearing protection when operating the unit.
6. Do not stand on or use the unit as a handhold.
7. **Periodic inspection and test of this equipment is required.** Consult your installer and local codes to meet all requirements.
8. Check all fasteners at frequent intervals for proper tightness.

1.4 Safety Notes



- This compressor is not equipped and should NOT be used "as is" to supply breathing quality air.



- Motors, electrical equipment and controls can cause electrical arcs that will ignite flammable gas or vapor. Never operate or repair in or near flammable gas or vapor. Never store flammable liquids or gasses near the compressor.



- These compressors are suitable for pumping only atmospheric air. As defined in Compressed Gas Association Pamphlet G-7, page 3, atmospheric air is a mixture of elements and compounds where nitrogen and oxygen comprise more than 99% with all other trace gasses comprising less than 1%. **Do not use this compressor in contaminated environments or for pumping mixtures other than atmospheric air.**



- Compressed air contains liquid water and is saturated with water vapor, which can freeze when surrounding temperatures are lower than 32°F (0°C). Component selection to minimize the effects of water vapor must be considered.

Section 2 - Receiving

Your compressor is inspected at the factory and packaged to protect against shipping damage. When the compressor is unpacked, inspect for damage or missing parts. All claims should be settled directly with the freight company.



- Do not operate this compressor if damaged during shipment, handling or use. Any damage may result in failure and cause injury or property damage.

Section 3 - Installation Location

Locate the compressor in a clean, well ventilated area where air is relatively cool, clean and dry. A 110°F (43°C) maximum and 40°F (4.5°C) minimum temperature for surrounding and inlet air are recommended. Provide at least 12 to 18 inches of clearance from any wall or other obstruction that will interfere with airflow over and through the compressor. Blocking airflow through the fan may cause the compressor to overheat. Do not place the compressor in an area of excessive heat, such as near a boiler.

Section 4 - Mounting

4.1 General Information

OL compressors (Riser mounted units) may be mounted to a firm level floor, wall or system riser. A mounting bracket and straps are provided. Tank mounted units must be leveled and anchored to the floor; the vibration isolators (P/N KVP4X4) supplied with the unit must be used. Both tank and riser mounted units are shipped with a flex hose and union. The flex hose (P/N P3002MP) is recommended to be installed between the compressor or tank outlet and service piping.

4.2 Basic Instructions - Riser Plate Mounting

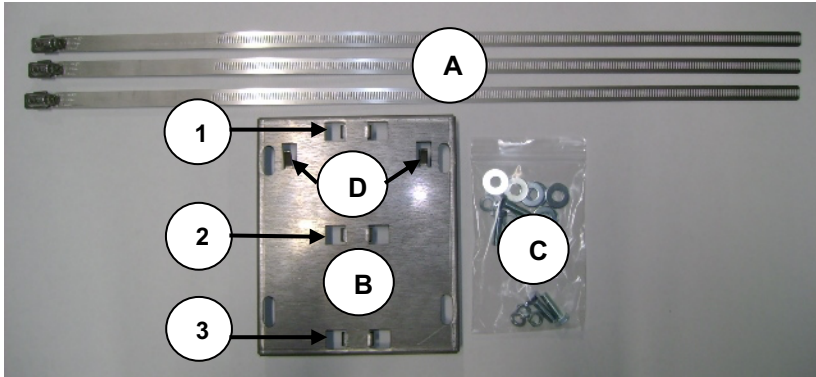

- RMK – Riser Mounting Kit Contents:**
- A – Mounting Straps:** Each RMK comes with 3 mounting straps.
 - B – Riser Mounting Plate**
 - C – Nuts, Bolts and Washers.** Necessary for mounting.
 - ★ **D - NEW – Compressor Hooks**

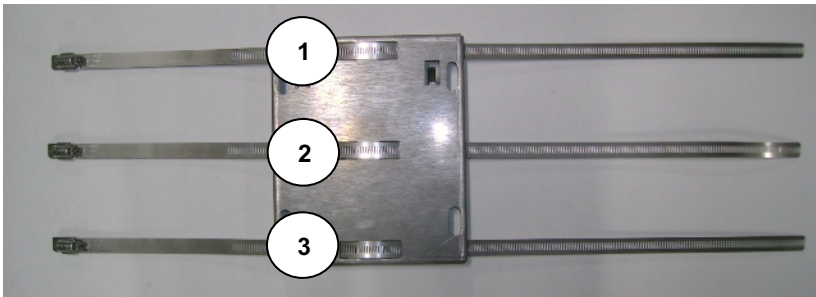

Bring the mounting strap in from the back side through the left hole, pass over the front of the plate and put the strap through the right. Repeat for straps 2 and 3.

Note: Once you have threaded the straps into mounting plate we recommend that you mount the plate to the riser. Ensure the compressor hooks are on the top and that all three straps are tight against the riser (no slack).

Notice: It is highly recommended that the installer have assistance when handling the **compressor** during installation or removal.

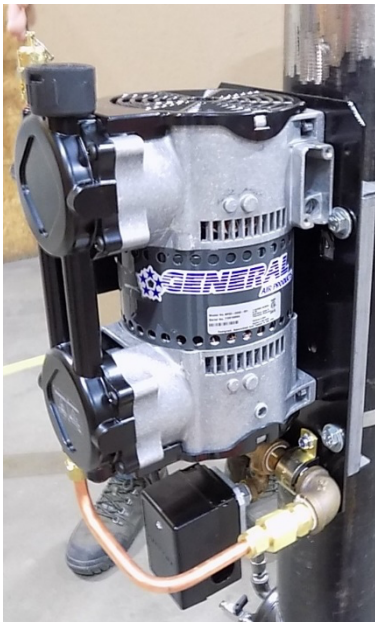

After the mounting plate is properly mounted on the riser, secure the compressor on its base to the plate using the compressor hooks to temporarily hold the compressor in place. Then use all four (4) nuts, washers and bolts to permanently mount the compressor to the plate.

Straps must be 90° angle to riser for proper installation.

IMPORTANT NOTES:

- 1) Torque straps screws to 35 to 40 in – lbs.
- 2) We highly recommend that the compressor is mounted to the riser with the discharge port is pointing down (as shown).
- 3) All four (4) bolts, washers and nuts supplied with the mounting kit must be used to secure the compressor to the plate. **Failure to do so will void warranty.**

Section 5 – Lubrication



NOTICE

This compressor is designed for non-lubricated service. Bearings are permanently lubricated. **Do not lubricate any part of the compressor or motor.**

Section 6 - Piping

6.1 Piping Instructions



- Compressed air contains liquid water and is saturated with water vapor, which can freeze when surrounding temperatures are lower than 32°F (0°C). Component selection to minimize the effects of water vapor must be considered.

Piping between the compressor, accessory items and the sprinkler system must be at least ½" internal diameter to minimize pressure drop from the compressor to system. Larger pipe size may be required by code and may be substituted with no adverse effects.



- Smaller line size must not be used and will restrict the compressor flow, lowering capacity and causing the compressor/motor to work harder, which shortens compressor/motor life. All piping connected to the compressor must be fully supported and not transfer any loads to the compressor.

If an AMD-1 is used, allow sufficient distance between the compressor and AMD-1 to ensure that the maximum temperature at the AMD-1 is 200°F or less.



- When an AMD is used with riser mounted units, a riser mounted tank kit (P/N OLR-TK) is recommended to prevent short cycling the compressor.

All oilless compressors include a relief valve. For riser mounted models, an ASME Code relief valve is installed on the compressor. For tank mounted models, an ASME Code relief valve is mounted on the compressor tank. This valve will open at a preset value above the pressure switch setting to prevent excess tank pressure in the event of a switch failure.



- Do not attempt to change the safety relief valve setting.

A manual drain is provided on the bottom of each tank mounted compressor. Moisture accumulated in the tank must be drained weekly. An automatic drain, P/N DVA-2T, is recommended in areas of high humidity.

The compressor outlet piping should contain an accessible drain. As a minimum a manual drain may be used, but an automatic drain is recommended to remove excess water.



- Accumulation of condensed water in the system can cause corrosion of components and reduction of system capacity.



- Warranty is void if a separate check valve is not installed to prevent water backflow to compressor.

Section 6 - Piping

6.2 OL Series Riser Mounted Oilless Air Compressor Installation Drawing

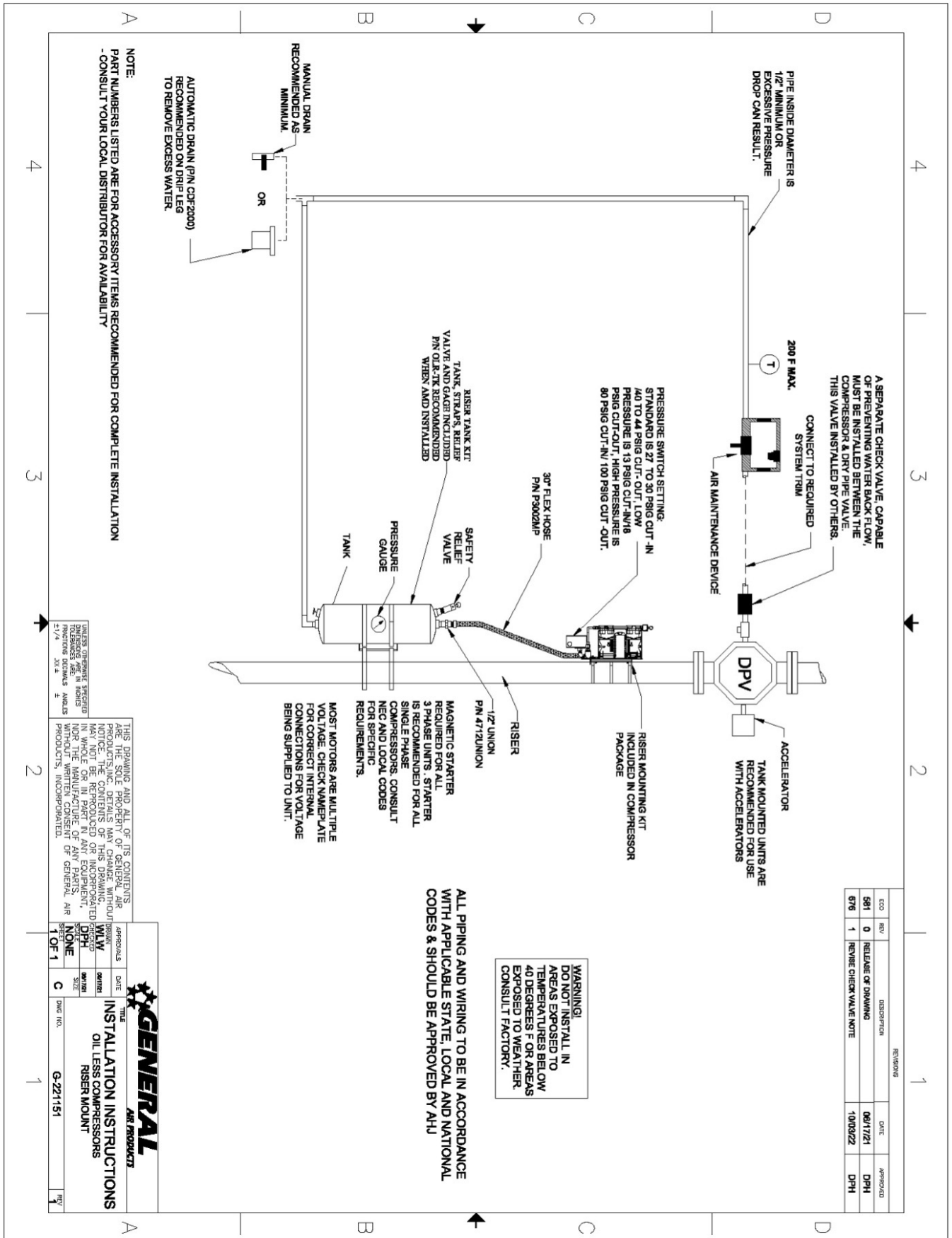

NOTE:
PART NUMBERS LISTED ARE FOR ACCESSORY ITEMS RECOMMENDED FOR COMPLETE INSTALLATION
- CONSULT YOUR LOCAL DISTRIBUTOR FOR AVAILABILITY

AUTOMATIC DRAIN (P/N CDF2000)
RECOMMENDED ON DRIP LEG
TO REMOVE EXCESS WATER.

MOST MOTORS ARE MULTIPLE
VOLTAGE. CHECK NAMEPLATE
FOR CORRECT INTERNAL
CONNECTIONS FOR VOLTAGE
BEING SUPPLIED TO UNIT.

ALL PIPING AND WIRING TO BE IN ACCORDANCE
WITH APPLICABLE STATE, LOCAL AND NATIONAL
CODES & SHOULD BE APPROVED BY AHJ

WARNING!
DO NOT INSTALL IN
AREAS EXPOSED TO
TEMPERATURES BELOW
40 DEGREES F OR AREAS
EXPOSED TO WEATHER.
CONSULT FACTORY.

ECO	REV	DESCRIPTION	DATE	APPROVED
561	0	RELEASE OF DRAWING	06/17/21	DPH
676	1	REMOVE CHECK VALVE NOTE	1/03/22	DPH

THIS DRAWING AND ALL OF ITS CONTENTS
ARE THE SOLE PROPERTY OF GENERAL AIR
PRODUCTS, INC. DETAILS MAY CHANGE WITHOUT
NOTICE. THE CONTENTS OF THIS DRAWING
IN WHOLE OR IN PART IS NOT TO BE REPRODUCED
OR TRANSMITTED IN ANY FORM OR BY ANY
MEANS, WITHOUT THE WRITTEN CONSENT OF GENERAL AIR
PRODUCTS, INCORPORATED.

GENERAL AIR PRODUCTS

INSTALLATION INSTRUCTIONS
OIL LESS COMPRESSORS
RISER MOUNT

DATE NO. G-22/1151

1 OF 1

Section 6 - Piping

6.3 OLT Series Tank Mounted Oilless Air Compressor Installation Drawing

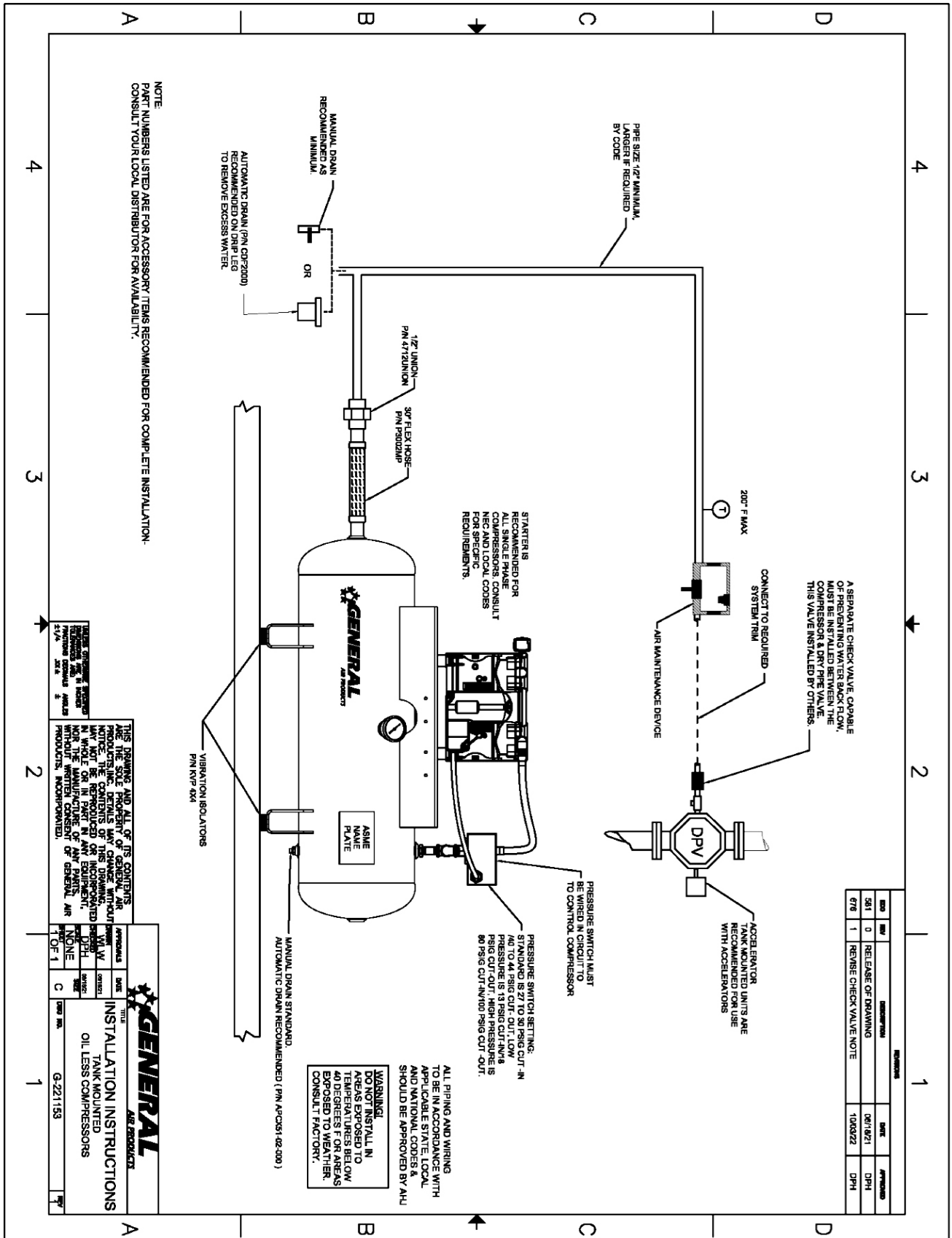

Section 6 - Piping

6.4 OLB Series Base Mounted Oilless Air Compressor Installation Drawing

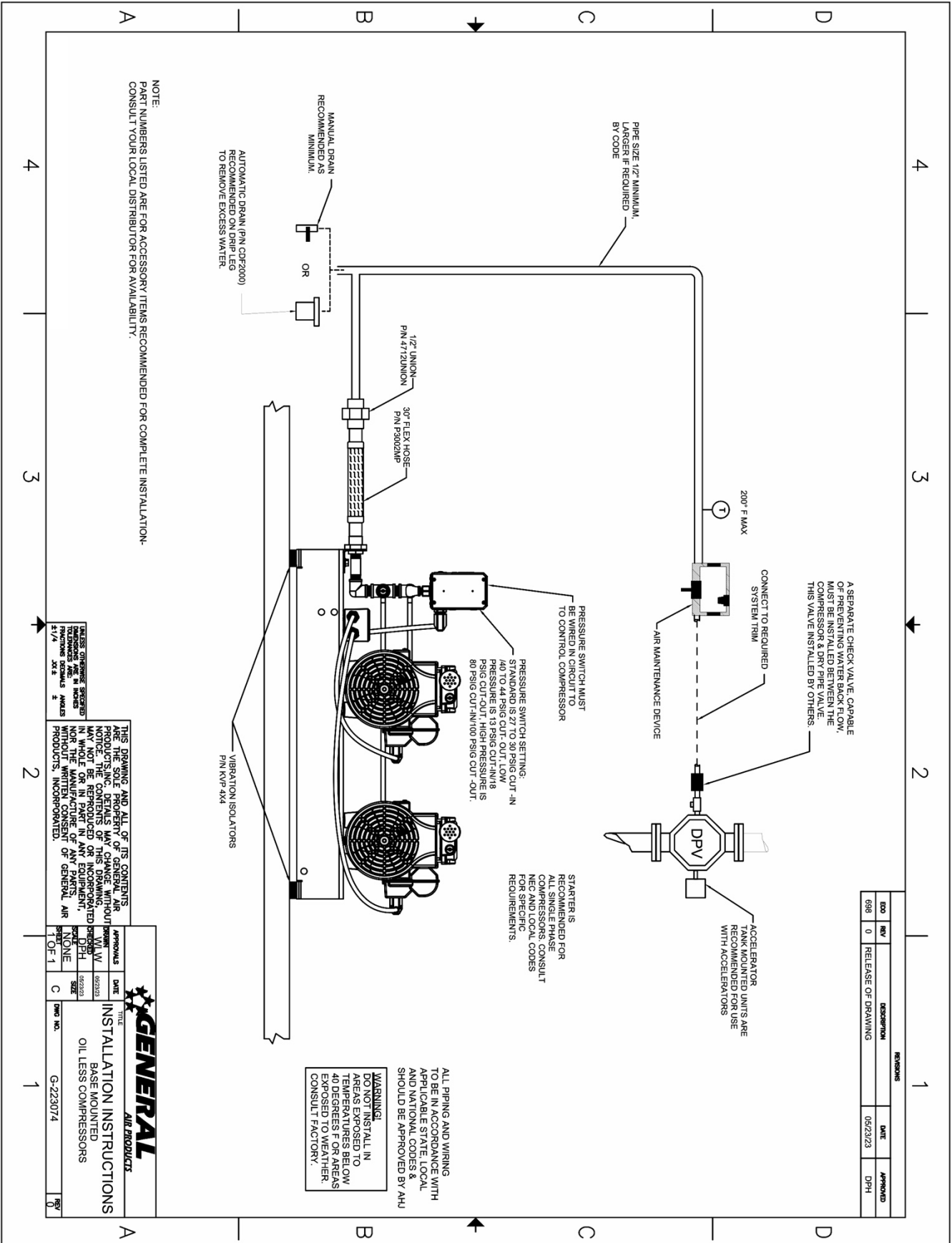

Section 7 - Wiring

7.1 Wiring Instructions



- Wiring should be in accordance with the national electrical code and any local codes or regulations. Have a licensed and competent electrician ensure that the voltage supplied matches the compressor voltage.



- Inadequate wiring size can cause insufficient voltage at the compressor during start-up. Overheating and damage can result to the motor and controls.



- Failure to use the pressure switch may result in overpressure of the compressor or other components in the system. Overpressure of the compressor can result in blown head gaskets or other damage.



- Grounding Instructions: This product must be connected to a grounded, metallic, permanent wiring system, or an equipment grounding terminal or lead on the product.

The supply wire must be of adequate size and no other equipment should be connected to the same line. The adjacent table lists the recommended wire size for each model based on a 100' run and lowest operating voltage. Consult factory for longer runs. The motors supplied are multiple voltage motors. A label on the pressure switch cover indicates the voltage the motor is pre-wired for. If the supply voltage, on site, is different from the voltage indicated on this label, change the internal motor voltage connections to match the supply voltage. To change internal voltage connections, remove the cover plate located on the rear or side of the motor and reconnect the wire leads as shown on the **motor's wiring diagram**.

On all three phase compressors an arrow on the motor indicates the required direction of rotation of the compressor. If the compressor rotates in the opposite direction, reverse the rotation of the motor. Interchanging any two incoming supply wires reverses rotation of three phase motors.

Minimum Recommended Wire Size			
Advance Model # With Digital Switch	Plus Model # With Mechanical Switch	1 Phase	3 Phase
OL(*)V12016**	OL(*)12016**	12	N/A
OL(*)V25033**	OL(*)25033**	12	N/A
OL(*)V40050**	OL(*)40050**	10	12
OL(*)V50075**	OL(*)50075**	10	12
OL(*)V600100**	OL(*)600100**	10	12
OL(*)V915150**	OL(*)915150**	6	12
OL(*)V1225200**	OL(*)1225200**	10	10
	OL(*)32016**-LP	12	N/A
	OL(*)55033**-LP	12	N/A
	OL(*)86050**-LP	12	12
	OL(*)99575**-LP	12	12
	OL(*)25033**-HP	10	N/A
	OL(*)40050**-HP	8	12
	OL(*)50075**-HP	8	12
	OL(*)600100**-HP	8	12

Replace * with "T" for tank mount models or "R" for riser mount models. Replace ** with "AC" for single phase or "BC" for three phase.



- Single-phase motors include internal thermal overload protection, which has an automatic reset device.



- Disconnect electrical power before servicing to disable reset devices. Thermal protection can automatically start the motor when the protector resets.

On single phase models, the motor is pre-wired to the pressure switch provided, which controls starting (cut in pressure) and stopping (cut out pressure) of the motor. The pressure switch is factory set. Standard models switch is set at 27 to 30 psig cut in and 40 to 44 psig cut out. Low pressure models ("-LP") switch is set at 13 psig cut in and 18 psig cut out. Consult General Air Products before adjusting the pressure switch.

On three-phase compressors, the motor is not pre-wired to the pressure switch. Refer to the three-phase wiring instruction drawing for recommended wiring. **A motor starter is required, for all three phase models, to protect the motor from overload conditions to meet NEC, NFPA 70, Article 430. A motor starter is recommended, for all single-phase models.** Consult the National Electric Code and local codes for motor starter requirements. Refer to the proper wiring instruction drawing for recommended wiring to a starter.



- Do not run two phases of a three-phase supply through the pressure switch directly to the compressor motor. Serious damage can result. Warranty is voided if connected this way.

Plus Series compressors use a mechanical pressure switch. All single-phase motors up to 1 ½ hp OLR(T)915150AC are factory wired for 115 volts/1Ph/60Hz supply. OLR(T)1225200AC are factory wired for 230V/1Ph/60HZ. To change OLR(T)12016AC to OLR(T)915150AC to 230 volts for a 230 volt single phase supply, rewire the motor to high voltage per the label on the side of the motor or inside the capacitor cover on OLR(T)12016AC and OLR(T)600100AC and reconnect the pressure switch as shown in section 7.1. Section 7.2 contains diagrams for connecting single and three phase compressor motors using motor starters.

Advance Series compressors use a digital pressure switch to control on and off pressures of the compressor motor. Single phase compressors with supply up to 240 volts/50z/60 Hz can be wired directly to the pressure switch following the diagrams in section 7.3. Section 7.3 also contains diagrams for connecting single and three phase compressor motors using motor starters.

If you have any questions regarding wiring, please call 1-800-345-8207 for assistance.



Do not adjust differential screw on mechanical pressure switches. The differential must not be decreased or the switch will not operate correctly and damage to the compressor can occur.

Section 7 - Wiring

Convert Mechanical Pressure Switch from 115V to 230V

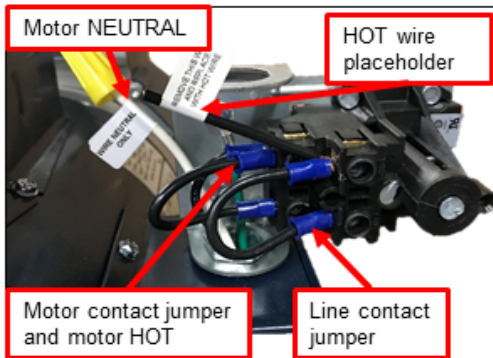

1. Identification of wires.

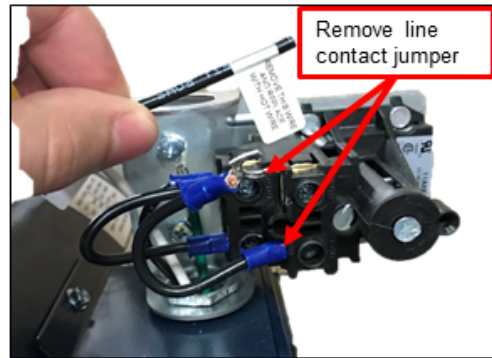

2. Remove line contact jumper and HOT wire placeholder.

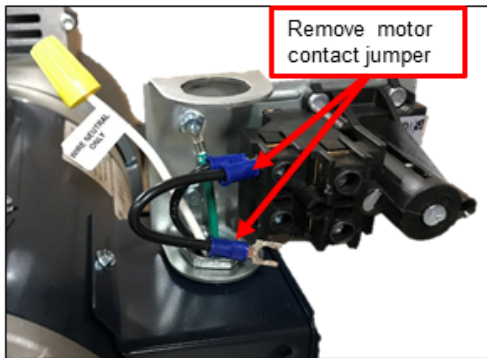

3. Remove motor contact jumper, leaving motor HOT in terminal. Retighten motor HOT wire in terminal.

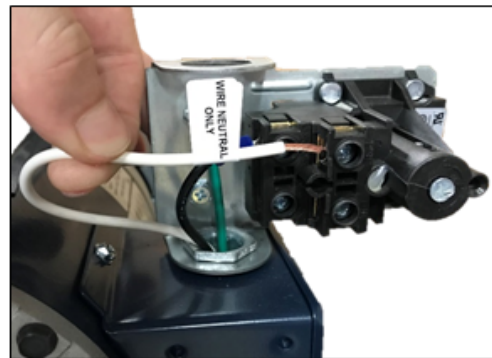

4. Remove yellow wire nut from motor NEUTRAL.

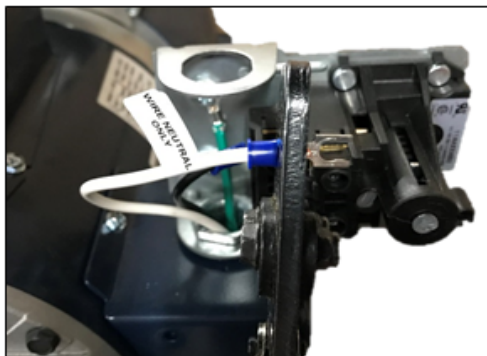

5. Crimp a spade connector onto NEUTRAL wire.

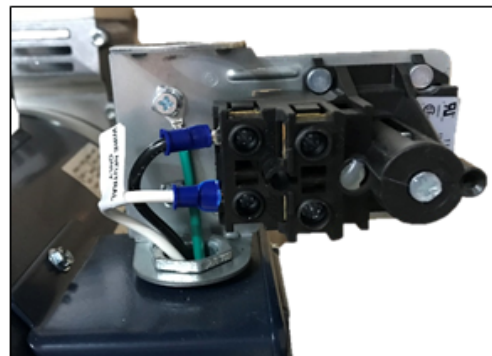

6. Insert spade connector into other motor terminal. Use wiring diagram on side of motor to wire it for 230V.

7. Wire supply line 1 and line 2 to line contacts of pressure switch.

Section 7 - Wiring

7.2 Oilless Air Compressor Single & 3 Phase Wiring Drawing with Mechanical Pressure Switch

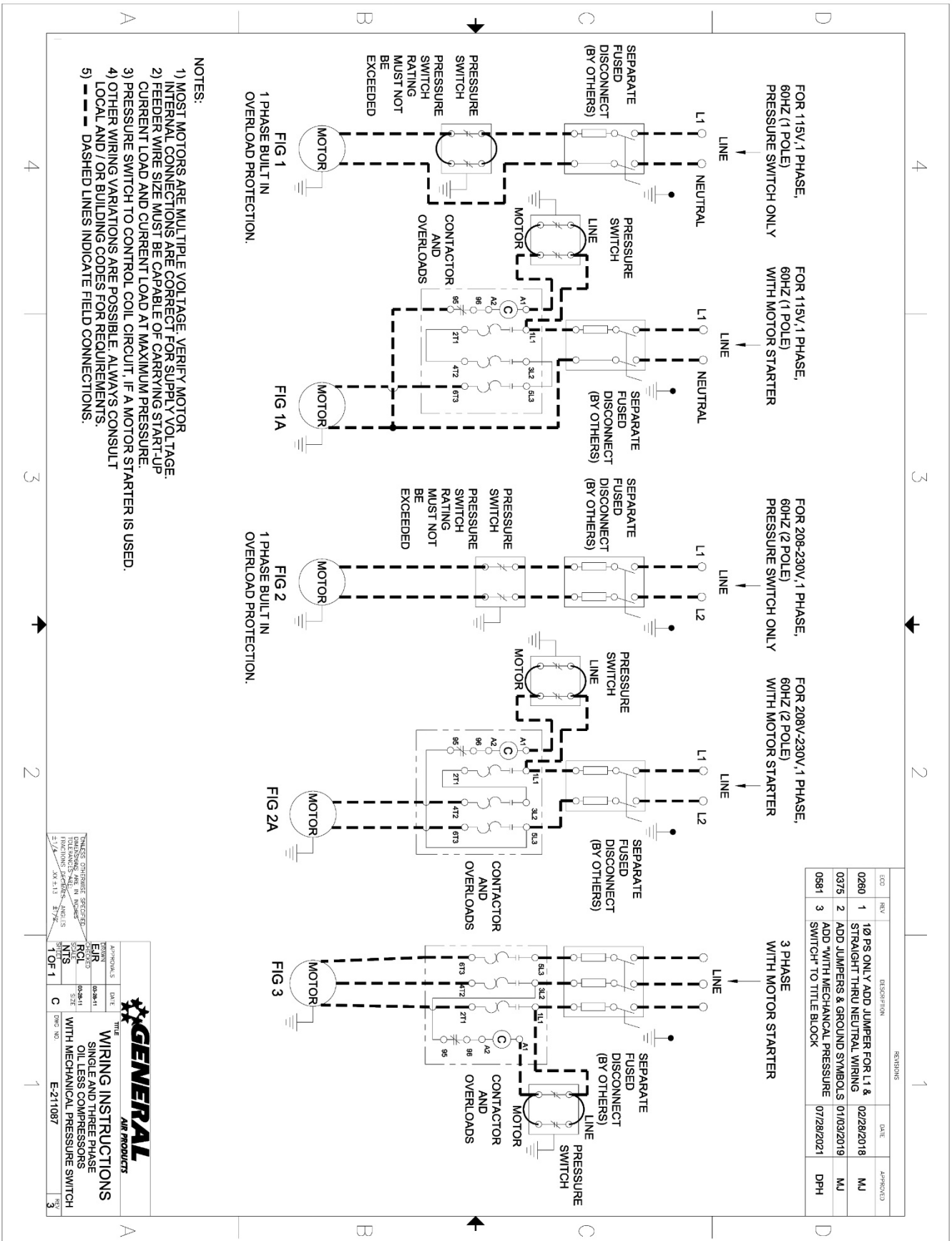

ECO	REV	DESCRIPTION	DATE	APPROVED
0260	1	10 PS ONLY ADD JUMPER FOR L1 & STRAIGHT THRU NEUTRAL WIRING	02/28/2018	MJ
0375	2	ADD JUMPERS & GROUND SYMBOLS	01/03/2019	MJ
0561	3	ADD "WITH MECHANICAL PRESSURE SWITCH" TO TITLE BLOCK	07/28/2021	DPH

GENERAL AIR PRODUCTS

TITLE
WIRING INSTRUCTIONS
SINGLE AND THREE PHASE
OIL LESS COMPRESSORS
WITH MECHANICAL PRESSURE SWITCH

REV
DATE
02/28/18
06/26/11
06/26/11

APP'D
EJR
RCL
MNS

CHK'D
T-O-F-1
C

DATE
02/28/18
06/26/11
06/26/11

SIZE
E211087

REV
3

TOLERANCE UNLESS SPECIFIED:
DIMENSIONS ARE IN INCHES
FRACTIONS ARE TO BE USED
DECIMALS ARE TO BE USED
UNLESS OTHERWISE SPECIFIED
DIMENSIONS ARE TO BE USED
UNLESS OTHERWISE SPECIFIED

Section 7 - Wiring

7.3 Oilless Air Compressor Single & 3 Phase Wiring Drawing with Digital Pressure Switch

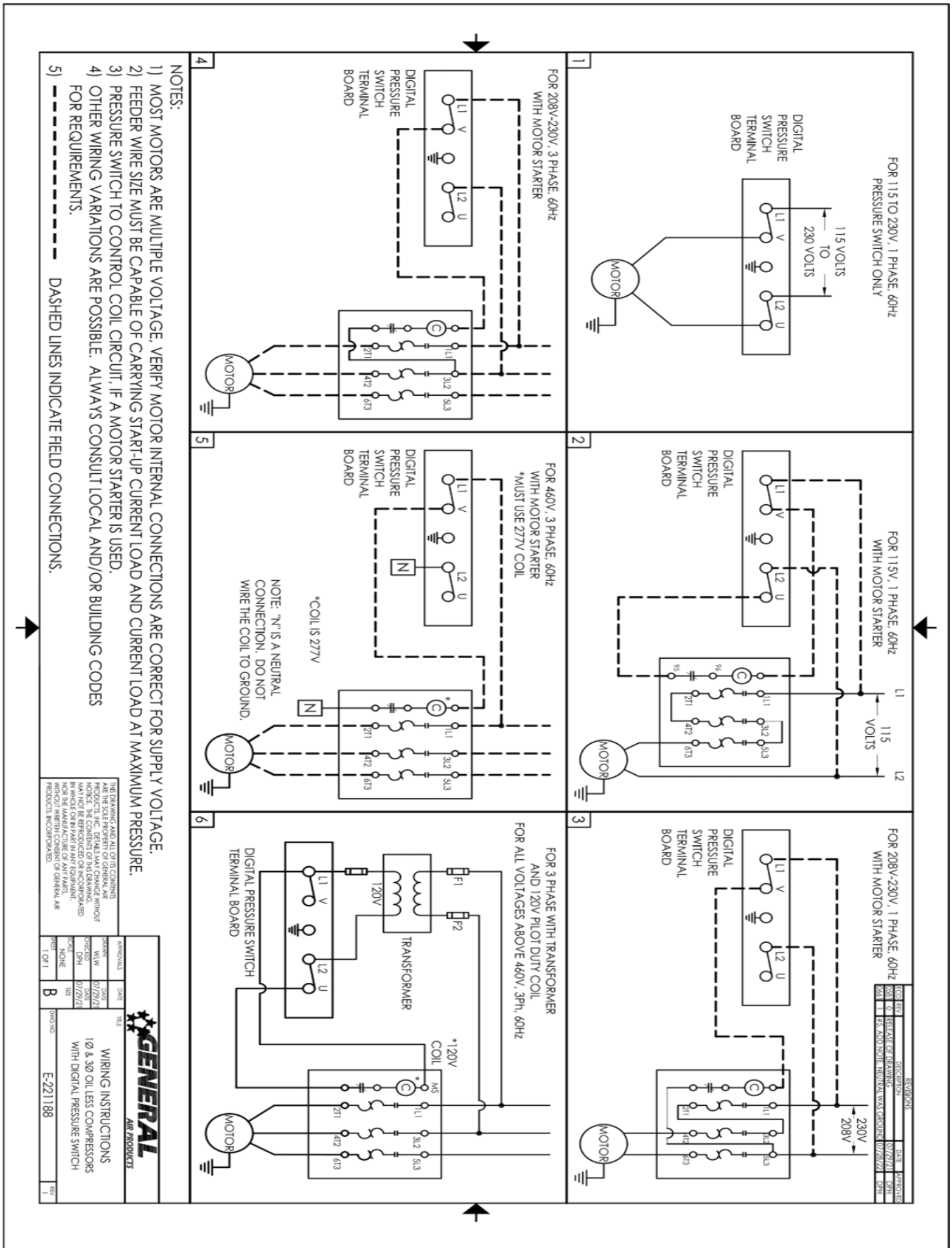

Section 8 - Maintenance Instructions



- Disconnect, tag, and lock out power source then release all pressure from the system before attempting to install, service, relocate, or perform any service.



Maintenance instructions for General Air Products lubricated air compressors:

The following instructions are based on normal operation. If the compressor is in an excessively dusty area, increase frequency of maintenance checks.

Quarterly and as needed:

- Air compressor is free of physical damage.
- Electrical power wiring to the air compressor is intact and free of physical damage.
- Piping from the air compressor to the fire protection system is secure, tight and free of physical damage.
- Check for unusual noise or vibration
- Drain condensate from air receiver and traps and/or test automatic drains for functionality
- Clean air filters (only with non-petroleum products)
- Clean all external parts of the compressor and motor
- Manually test safety relief valve
- Inspect air system for leaks
- Tighten all fittings, nuts, and screws as required

Annually and as Needed:

All quarterly checks plus the following:

- Change air intake filters



The maintenance instructions below are per NFPA 25 Code Requirements:

13.10.2 - Inspection

Air Compressors dedicated to water-based fire protection systems shall be inspected monthly to verify the following:

1. Air Compressor is free of physical damage.
2. Power wiring to the air compressor is intact and free of physical damage.
3. Piping from the air compressor to the fire protection system is intact and free of physical damage.
4. The means of anchoring the air compressor to the structure or to the system piping is secure, tight, and free of physical damage.

13.10.3 - Testing

Air Compressors dedicated to water-based fire protection systems shall be tested annually to verify the following:

1. Air compressor operates as intended on the proper drop of air pressure in the fire protection system.
2. Air compressor restores normal air pressure in the fire protection system in the required time frame.
3. Air compressor does not overheat while running.

13.10.4 – Maintenance

Air Compressors dedicated to water-based fire protection systems shall be maintained in accordance with the manufacturer's instructions (see above instructions).

If there are any questions regarding installation, operation, or maintenance of this compressor, please call 800-345-8207

Section 9 - Troubleshooting Guide

Symptom	Possible Cause(s)	Corrective Action
Motor hums and runs slowly or not at all.	<ol style="list-style-type: none"> 1. Low or no voltage 2. Shorted or open motor winding 3. Defective check valve 4. Defective pressure switch - contacts will not close 	<ol style="list-style-type: none"> 1. Check voltage during start. Voltage must be within +/- 10% of nominal voltage to start motor. Increase wire size if necessary, to lower voltage drop. 2. Replace compressor 3. Replace check valve 4. Repair or replace pressure switch
Reset mechanism cuts out or fuses blow repeatedly	<ol style="list-style-type: none"> 1. Insufficient voltage to motor 2. Pressure switch set too high 3. Wrong fuse size 4. Piping too restrictive 5. Defective motor 	<ol style="list-style-type: none"> 1. Check voltage during start. Voltage must be within +/- 10% of nominal voltage to start motor. Increase wire size if necessary, to lower voltage drop. 2. Consult factory, adjust or replace 3. Be sure fuses, heaters and/or overloads are properly rated or set 4. Add receiver vessel or increase pipe volume after compressor 5. Consult factory
Unit short cycles repeatedly	<ol style="list-style-type: none"> 1. Piping too restrictive 2. Air leaks 	<ol style="list-style-type: none"> 1. Add receiver vessel or increase pipe volume after compressor 2. Repair leaks
Compressor overheating	<ol style="list-style-type: none"> 1. Dirty intake filter 2. Wrong motor rotation 3. Air flow to fan blocked 	<ol style="list-style-type: none"> 1. Clean intake filter 2. Correct rotation 3. Clean air flow to fan or relocate unit
Excessive noise in operation	<ol style="list-style-type: none"> 1. Damaged bearings 2. Worn piston cup 3. Broken valves 4. Loose fan 5. Damaged fan guard 	Contact General Air Products for technical support by calling 1-800-345-8207
System pressure builds slowly	<ol style="list-style-type: none"> 1. Compressor sized incorrectly 2. Leaks or restrictions in piping 3. Dirty intake filter 	<ol style="list-style-type: none"> 1. Check system size and compressor sizing 2. Correct leaks and remove restrictions 3. Clean intake filter

Section 10 - Warranty Policy

GENERAL PROVISIONS & LIMITATIONS

General Air Products, Inc. (the "Company") warrants to each original purchaser ("Purchaser") of its new products from the Company or its Authorized Distributor that such products are, at the time of delivery to the Purchaser, made with good materials and workman- ship. No warranty is made with respect to:

1. Any product, which has been repaired or altered in such a way, in the Companies judgment, as to affect the product adversely.
2. Any product, which has, in the Companies judgment been subjected to negligence, accident, improper storage, improper installation or application.
3. Any product, which has not been operated or maintained in accordance with the recommendations of the Company.
4. Components or accessories manufactured, warranted and serviced by others.
5. Any reconditioned or prior owned product.

Claims for items described in 4. above should be submitted directly to the manufacturer.

WARRANTY PERIOD

The Company's obligation under this Warranty is limited to repair or, at its option, replacing during normal business hours at the designated facility of the Company, any part that in its judgment proved not to be as warranted within the applicable Warranty Period as follows.

COMPONENTS

All non-consumable components are warranted for 12 months from the date of purchase. Consumables are not covered under warranty. The unit must have been installed by either a factory authorized distributor or agent in accordance with the factory recommendations taking into account all other local site conditions not originally noted to the factory. The unit must be operated and maintained in accordance with the Factory recommendations and original design conditions. Failure to provide such proof of the above may void warranty.

LABOR TRANSPORTATION & INSPECTION

The Company will repair or replace any product or part thereof which in the Companies judgment is proved to be not as warranted. Labor costs are not covered under warranty.

All costs of transportation of product, labor or parts claimed not to be as warranted and, of repaired or replaced parts to or from factory shall be borne by purchaser. The Company may require the return of any part claimed not to be as warranted to one of its facilities as designated by the Company, transportation prepaid by Purchaser, to establish a claim under this warranty.

Replacement parts provided under the terms of the warranty are warranted for the remainder of the Warranty Period of the product upon which installed to the same extent as if such parts were original components.

DISCLAIMER

THE FOREGOING WARRANTY IS EXCLUSIVE AND IT IS EXPRESSLY AGREED THAT, EXCEPT AS TO TITLE, THE COMPANY MAKES NO OTHER WARRANTIES, EXPRESSED OR IMPLIED OR STATUTORY, INCLUDING ANY IMPLIED WARRANTY OR MERCHANTABILITY.

THE REMEDY PROVIDED UNDER THIS WARRANTY SHALL BE THE SOLE, EXCLUSIVE AND ONLY REMEDY AVAILABLE TO THE PURCHASER AND IN NO CASE SHALL THE COMPANY BE SUBJECT TO ANY OTHER OBLIGATIONS OR LIABILITIES. UNDER NO CIRCUMSTANCES SHALL THE COMPANY BE LIABLE FOR SPECIAL, INDIRECT, INCIDENTAL OR CONSEQUENTIAL DAMAGES, EXPENSES, LOSSES OR DELAYS HOWSOEVER CAUSED.

No statement, representation, agreement, or understanding, oral or written, made by any agent, distributor, representative or employee of the Company which is not contained in this Warranty will be binding upon the company unless made in writing and executed by an officer of the Company.

This warranty shall not be effective as to any claim which is not presented within 30 days after the date upon which the product is claimed not to have been as warranted. Any action for breach of this warranty must be commenced within one year after the date upon which the cause of action occurred.

Any adjustment made pursuant to this warranty shall not be construed as an admission by the Company that any product was not as warranted.

PROMPT DISPOSITION & RETURNS POLICY

The Company will make a good faith effort for prompt correction or other adjustment with respect to any product, which proves to be defective within the warranty period. Before returning any product, write or call the distributor, agent or authorized company from which the product was purchased, describing defect and giving date and number of original invoice, as well as proof of Factory supplied consumables and proof of scheduled maintenance. No products will be accepted for return without the Company issuing a "Returned Goods Authorization" (RGA) to the Purchaser and unless accompanied by a properly authorized RGA request form initiated by the Purchaser. Return freight must be prepaid and each returned product must have the RGA number clearly marked on the product. Title and risk of loss pass to buyer upon delivery to the common carrier.

PRODUCT SUITABILITY

Many States, Localities and Countries have codes and regulations governing sales, construction, installation, and/or use of products for certain purposes, which may vary from those in neighboring areas. While General Air Products, Inc. attempts to assure that its products comply with such codes, it cannot guarantee compliance, and cannot be responsible for how the product is installed or used? Before purchase and use of a product, please review the product application, and national and local codes and regulations, and be sure that the product, installation, and use will comply with them.

General Air Products, Inc.
118 Summit Drive
Exton, PA 19341
P: 610-524-8950
F: 610-524-8965

REV: 4/22/11